

Article number: 2310308115ESD

Description: E+G Antistatic base for levelling elements
LV.A-70-14-AS-M16x168-ESD-C

Measures

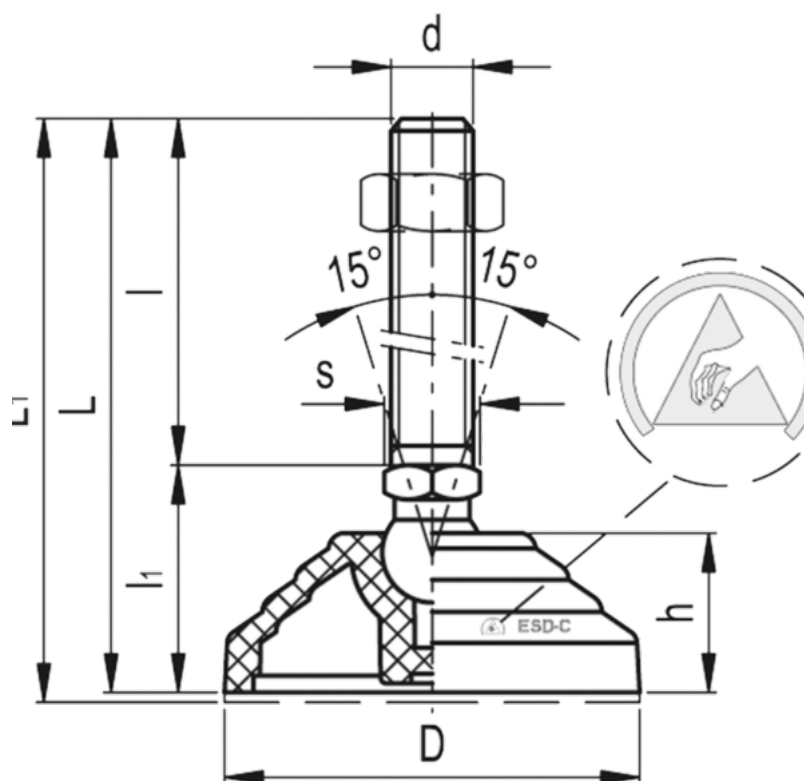

Articulation = 14	Max load = 14000
D = 70	s = 16
d = M16	Weight in (g) = 290
h = 19	
l = 168	
L1 = 28	
L = 196	
L1 = 199	